

Profiles

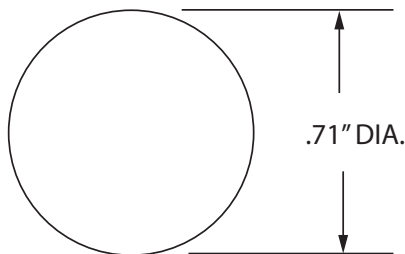
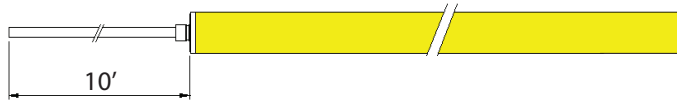

**Please verify the contents of the packages!**

**Please read instructions entirely before starting installation**

**Be sure power is turned off before installing the system**

**Call Tivoli, LLC tech support with questions**

**Caution:** Flexile SM is designed to work with listed class 2 24V DC transformers only. Use of any other power source will cause damage, shorten the life of the fixture and will void the warranty.

**Consult** any and all applicable local and national codes for installation

**Do not** conceal or extend exposed conductors through a building wall as per local electrical code.

**Warning:** With any luminaire for any application, basic safety precautions should always be followed to reduce the risk of fire, electric shock and personal injuries. This lighting system should be installed by a certified professional.

Overview



Flexile is a rugged and flexible 360° Lighting unit that replicates the warm glow of neon. Bend Flexile to any shape with a minimum radius of 1.19". The fixture material is resistant to saline solutions, acids, alkali, and corrosive gasses. Additionally, the exterior housing material is made with UV stabilized food-grade environmental silicone which is designed for outdoor use. There will be no yellowing or cracking.

**WARNING!** Risk of Product Damage.  
Do not immerse in water as product damage may result. Flexile is rated IP65 for outdoor use.

**WARNING!** Risk of Shock.  
Do not cut into this product in any way. Flexile is not designed to be cut in the field. Determine length requirements when ordering from the factory.

This instruction covers three available methods for attaching Flexile to mounting surfaces: Plastic Mounting clips, Short Channel Clips and long Channels. Use Plastic Clips for tighter curves and more intricate patterns. Use the Short Channel Clips for runs with straight and curved sections. Use the 6.5' Long Mounting Channel for long straight runs. Consult factory for various mounting option bending radii.

**WARNING!** Risk of Product Damage.  
Do not bend tighter than a minimum radius of 1.25"

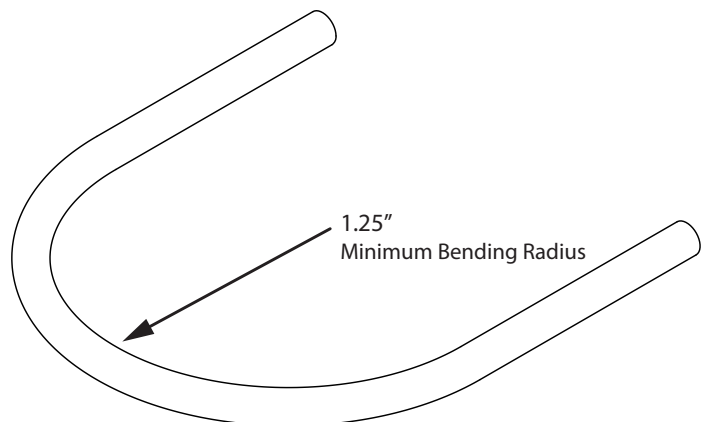

Total Maximum Run Length		
Luminaire	Watts/ft	Maximum Run Electrical Length
Flexile SM	4.5	20'

7101014

## Installing Flexile with Plastic Clips

### FLEX-SM-CL-CLIP

Use the Clear Plastic Clips for tighter, more intricate layouts.  
Mounting Spacing 15". Bend Diameter 2.5".

**Step 1:** Determine the location and shape for the Flexile Fixture.

**Step 2:** Position the Flexile against the mounting surface at the first mounting location and position the Clear Plastic Clips over the Flexile housing.

**Step 3:** Secure Clear Plastic Clips to surface using No. 6 screws (supplied by others) appropriate for mounting surface, ie: wood screws for wood.

**Step 4:** Locate the next Flexile mounting position and place the Clear Plastic Clips over the Flexile housing and attach with screws.

**Step 5:** Continue to attach mounting clips until the entire length of Flexile is secured to the mounting surface.

**Step 6:** Connect lead wire to power supply.

**WARNING!** Risk of Product damage.  
Do not exceed the maximum run length.

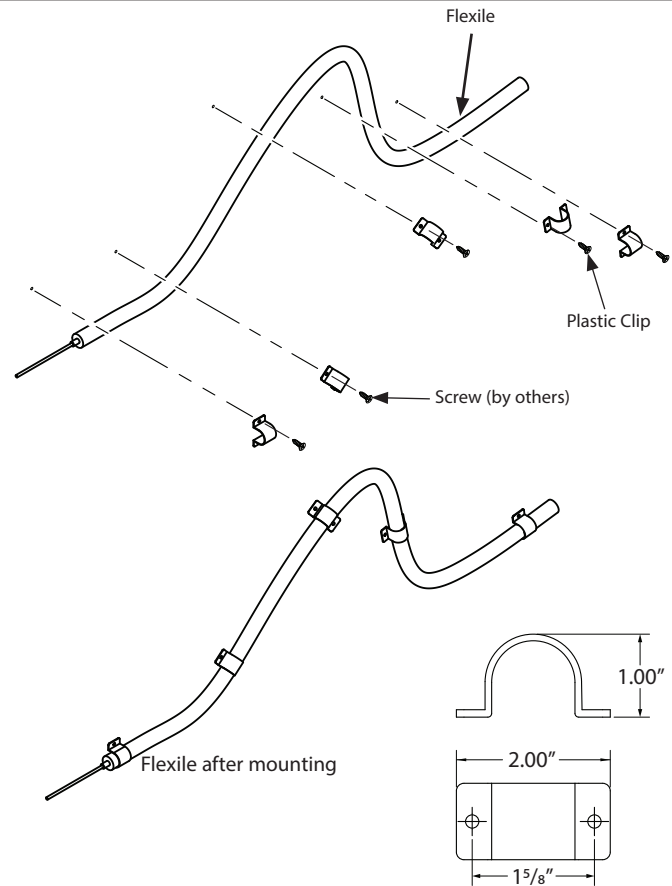

## Installing Flexile with Short Channel Clips

### FLEX-SM-OP-CLIP

Use the Short Channel Clips for designs with a combination of straight and curved sections. For wall mount only.  
Mounting Spacing 15". Bend Diameter 3".

**Step 1:** Determine the location and the shape for the Flexile Fixture.

**Step 2:** Attach the Short Channel Clips on the mounting surface following the design pattern. Secure to surface using No. 6 screws (supplied by others) appropriate for mounting surface, ie: wood screws for wood.

**Step 3:** Press the Flexile body into each Short Channel Clip until the entire length of Flexile is mounted in all the Clips.

**Step 4:** Connect lead wire to power supply.

**WARNING!** Risk of Product damage.  
Do not exceed the maximum run length.

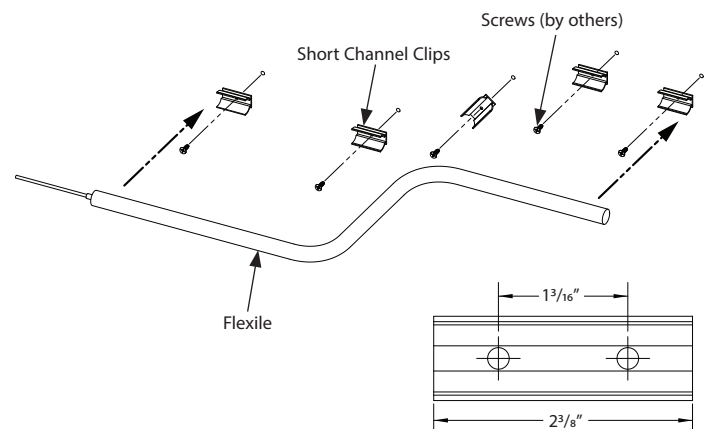

7101014

## Installing Flexile in Mounting Channel

### FLEX-SM-OP-CHAN

Use the Open Mounting Channel for straight runs of Flexile. Channel is supplied from the factory in 6 $\frac{1}{2}$ ' lengths. For wall mount only. Bend diameter between channels is 3"

**Step 1:** Determine the location for the Flexile Fixture.

**Step 2:** Attach the Mounting Channel on the mounting surface. Secure to surface using No. 6 screws (supplied by others) appropriate for mounting surface, ie: wood screws for wood.

**Step 3:** Press the Flexile body into the Mounting Channel starting at one end and continue to press down along until the entire length of Flexile until it is fully inserted in the Mounting Channel

**Step 4:** Connect lead wire to power supply.

**WARNING!** Risk of Product damage.  
Do not exceed the maximum run length.

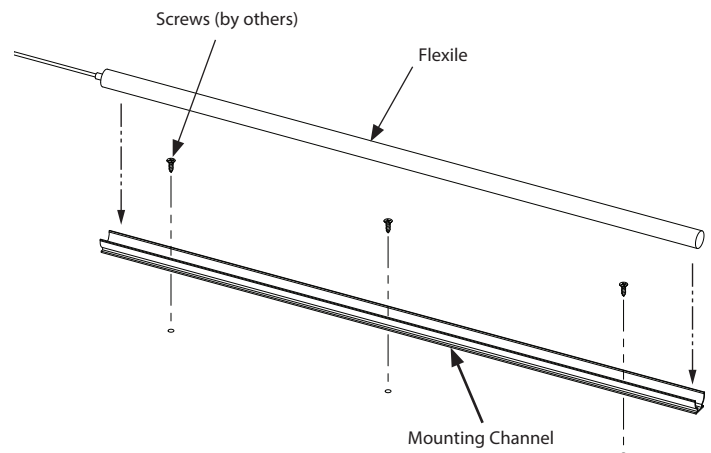

### FLEX-SM-CL-CHAN

Use the Closed Mounting Channel for surface mounting straight runs of Flexile. Channel is supplied from the factory in 6 $\frac{1}{2}$ ' sections. Bend diameter between channels is 2.5"

**Step 1:** Insert the Flexile Tube Light into the Channel by starting at one end and pressing along the length of the fixture until it is fully inserted in the channel.

**Step 2:** Attach the Mounting Channel/Flexile assembly to the mounting surface. Secure to surface using No. 6 screws (supplied by others) appropriate for mounting surface, ie: wood screws for wood.

**Step 3:** Connect lead wire to power supply.

**WARNING!** Risk of Product damage.  
Do not exceed the maximum run length.

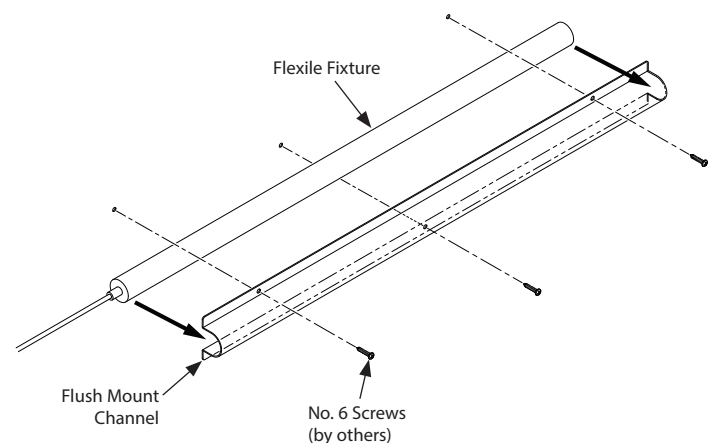

### Power Supply with 0-10V Sample Wiring Diagram

There are many possible options for dimming Flexile. See the specification sheet for more information. The following wiring diagram is for reference only. Please refer to the installation instruction for the power supply you choose for detailed wiring instructions.

