

CAT: FEET:

TYPE: PROJECT:



Twice the lumens as standard Titanium, Titanium HO LED PCBs were developed by Tivoli to be utilized as the primary light engine for many of our linear products. When utilized in a strand with 3/4" to 1 1/2" spacing it is a great tool for cove lighting as well. Often in tight cove applications service is an issue. Titanium™ Cove HO can be mounted with angled mounting clips for asymmetric applications or with the standard vertical clip. Additionally Titanium™ Cove HO can be installed in the Infinity or Titanium clear or frosted polycarbonate mounting channel with lens and end caps for dust free illumination. Titanium™ Cove HO has the option of 2 and 3 Nichia LEDs depending on your desired spacing, lumens and watts per foot requirements. Titanium™ Cove HO utilizes lower profile Titanium LED PCB modules that are attached to continuous through wires which minimizes voltage drop and feature nickel plated copper contacts for high contact reliability.

Features

- Titanium LED PCB in 2 and 3 LED variants
- High quality Nichia SMD LEDs
- Offered in 6 white color temps.
- Bendable on X and Y axis
- Angled and straight mounting options
- Two channel and lens options

Mounting

Use with Infinity Channel for vertical or horizontal applications. Use with Titanium Channel and lens for upward or downward illumination.

Applications

Ideal for mounting in ceiling cavities, recessed coves, walls, closets.

Warranty

5 years

Technical Information



LED Spacing	Series 01 (3/4")	Series 02 (1 1/2")
*Lumens/ft	321	214
*Watts/ft	3	2.4
*Lumens/watt	107	89
CRI	>80/TYP 84	
Kelvin Temp	2200K, 2500K, 2700K, 3000K, 3500K, 4000K (+/-80K) 3SDCM	
Rated Life	75,000 hrs.	
Max Run Length	20'	25'
Order Increments	1'	
Cut Increments	2.25"	3"
Operating Voltage	12V DC	
Power Supply Requirement	Class 2	
Dimmable	Yes	

*3000K Sample

Profile Dimensions

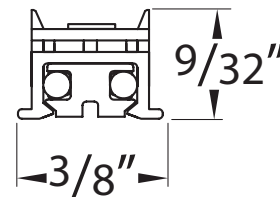

Series 01 - Triple LEDs with 3/4" O.C. Spacing

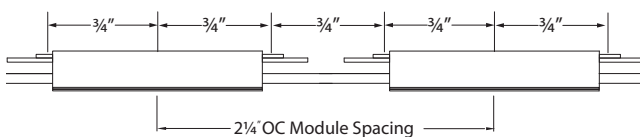

Series 02 - Double LEDs with 1 1/2" O.C. Spacing

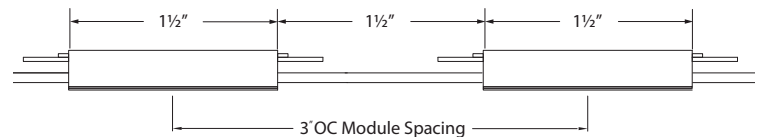

Recommended Power Supplies

ADUL - NON DIMMING

DESCRIPTION	CAT NO	APPLICATION	PRIMARY VOLTAGE	SECONDARY VOLTAGE	CIRCUIT BREAKERS	MAX LOAD	CIRCUIT CAPACITY
ADUL Series Class 2 Transformer	ADUL-80-1-5-12-D	Indoor / Damp	100-277V AC 5ø60 HZ	12V DC	1	60W	5A
	ADUL-150-2-5-12-D				2	2x60W	2x5A
	ADUL-240-3-5-12-D				3	3x60W	3x5A
	ADUL-320-4-5-12-D				4	4x60W	4x5A

ADUL - 0-10V DIMMING

DESCRIPTION	CAT NO	APPLICATION	PRIMARY VOLTAGE	SECONDARY VOLTAGE	CIRCUIT BREAKERS	MAX LOAD	CIRCUIT CAPACITY
ADUL Series Class 2 Transformer	ADUL-80-1-5-12-DOT	Indoor / Damp	100-277V AC 5ø60 HZ	12V DC	1	60W	5A
	ADUL-150-2-5-12-DOT				2	2x60W	2x5A
	ADUL-240-3-5-12-DOT				3	3x60W	3x5A
	ADUL-320-4-5-12-DOT				4	4x60W	4x5A

ADUL - DMX SINGLE ADDRESS

DESCRIPTION	CAT NO	APPLICATION	PRIMARY VOLTAGE	SECONDARY VOLTAGE	CIRCUIT BREAKERS	MAX LOAD	CIRCUIT CAPACITY
ADUL Series Class 2 Transformer	ADUL-80-1-5-12-DIN	Indoor / Damp	100-277V AC 5ø60 Hz	12V DC	1	60W	5A
	ADUL-150-2-5-12-DIN				2	2x60W	2x5A
	ADUL-240-3-5-12-DIN				3	3x60W	3x5A

ADUL - DMX MULTI ADDRESS

DESCRIPTION	CAT NO	APPLICATION	PRIMARY VOLTAGE	SECONDARY VOLTAGE	CIRCUIT BREAKERS	MAX LOAD	CIRCUIT CAPACITY
ADUL Series Class 2 Transformer	ADUL-150-2-5-12-DIN-2	Indoor / Damp	100-277V AC 5ø60 Hz	12V DC	2	2x60W	2x5A
	ADUL-240-3-5-12-DIN-3				3	3x60W	3x5A
	ADUL-320-4-5-12-DIN-4				4	4x60W	4x5A

INFINITY - MLV / ELV / 0-10V / PWM / TRIAC

DESCRIPTION	CAT NO	APPLICATION	PRIMARY VOLTAGE	SECONDARY VOLTAGE	CIRCUIT BREAKERS	MAX LOAD	MIN LOAD	CIRCUIT CAPACITY
Infinity Series Class 2 Transformer	INF-J-30-1-2.5-12	Indoor / Outdoor	100 - 277V AC	12VDC	1	30W	3W	2.5A
	INF-J-60-1-5-12				1	60W	6W	5A
	INF-J-180-3-5-12				3	3x60W	3x6W	3x5A
	INF-J-300-5-5-12				5	5x60W	5x6W	5x5A

Recommended Dimmers

DESCRIPTION	CAT NO	APPLICATION	INPUT VOLTAGE	OUTPUT VOLTAGE	PRICE
24V Plug-In	PIT-24VDC-28W	Indoor	120V AC	24V DC	\$ 39.00/ea

INDOOR 12V

DESCRIPTION	CAT NO	APPLICATION	INPUT VOLTAGE	OUTPUT VOLTAGE	PRICE
12V Plug-In	PIT-12VDC-12W	Indoor	120V AC	12V DC	\$ 18.00/ea

PLUG-IN END PREP (Optional)

CAT NO	WIRING END PREPS	PRICE
PIT-F-LEAD-12	Power lead with female barrel connector to bare wire 5.5mmx2.1mm 12inch cable 24AWG	\$ 10.00/ea

DIMMING - DMX

DESCRIPTION	CAT NO	APPLICATION	INPUT VOLTAGE	OUTPUT PROTOCOL	MAX UNIVERSE
DMX Controller	TVOQ-1-WH	Indoor	5V DC	DMX 512	1
	TVOQ-2-BK		6V DC		
	TVOQ-2-WH				
	TVOQ-10-BK-7				
	TVOQ-10-WH-7		6-7V DC		2



TVOQ-1-WH
WH (White only)

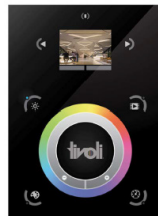

TVOQ-10-XX-7
XX = BK (Black), WH (White)

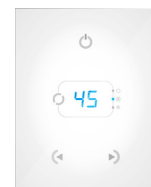

TVOQ-2-XX
XX = BK (Black), WH (White)

Ordering Information

PRODUCT CODE	LED SPACING	LED TYPE	LED COLOR	VOLTAGE	REQUIRED POWER SUPPLY
TCHO = Titanium Cove High Output BLACK TCHOW = Titanium Cove High Output *WHITE	Series 01 = 3/4" Series 02 = 1 1/2"	U = Ultra Bright SMD Chip	22 = 2200K 25 = 2500K 27 = 2700K 30 = 3000K 35 = 3500K 40 = 4000K	12 = 12V DC	PSU See Page 1

*Consult factory for lead time.

Wiring Accessories

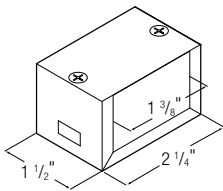

JBOX
Junction Box
Use to cover terminal block connections. One end of the terminal block screws directly into the Covelum™ LED lead wires, the other end accepts AWG # 10, 12, 14 wire from power supply. 1 each terminal block included.

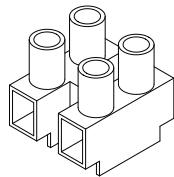

TERM-BLK
Terminal Block available separately.



TTCL-EP
BLACK - Straight Power Feed Lead:
Factory installed 24", 18 AWG Power Lead.
TTCLW-EP
WHITE - Straight Power Feed Lead:
Factory installed 24", 18 AWG Power Lead.

Mounting Accessories

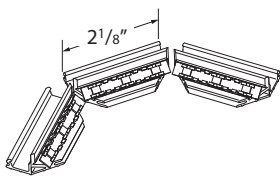

TTCL-MC-ANGLE
Angled Mounting Clamp
For radius installations with angled illumination. One clamp per module required. BLACK

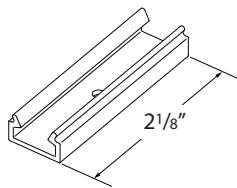

TTCL-MC-VERT
Mounting Clamp for radius installations

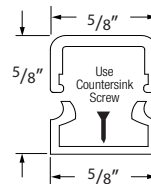

INF-C-CHAN-8
Infinity Mounting Channel and lens, 8 ft. length - Clear
INF-F-CHAN-8
Infinity Mounting Channel and lens 8' length - Frosted

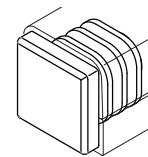

INF-EC
Infinity channel end-cap, BLACK

Mounting Accessories

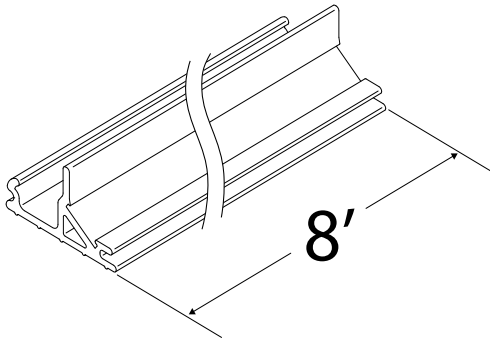

TTCL-CHAN-ANGLE-8
Angled Mounting Channel - 8' length

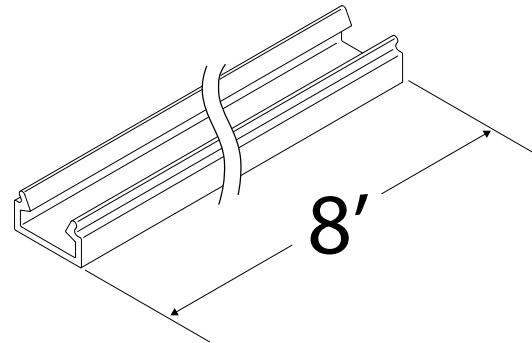

TTCL-CHAN-VERT-8
Mounting Channel for radius installations - 8' length

Replacement Parts

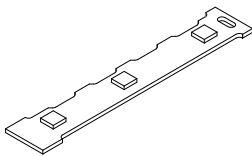

- | | |
|--|---|
| 01 SERIES SMD LED PCB
BLACK | 01 SERIES SMD LED PCB
*WHITE |
| TTCL-T120-U-22
2200K | TTCL-T120-U-22-W
2200K |
| TTCL-T120-U-25
2500K | TTCL-T120-U-25-W
2500K |
| TTCL-T120-U-27
2700K | TTCL-T120-U-27-W
2700K |
| TTCL-T120-U-30
3000K | TTCL-T120-U-30-W
3000K |
| TTCL-T120-U-35
3500K | TTCL-T120-U-35-W
3500K |
| TTCL-T120-U-40
4000K | TTCL-T120-U-40-W
4000K |
- *Consult factory for lead time.

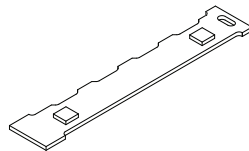

- | | |
|--|---|
| 02 SERIES SMD LED PCB
BLACK | 02 SERIES SMD LED PCB
*WHITE |
| TTCL-D120-U-22
2200K | TTCL-D120-U-22-W
2200K |
| TTCL-D120-U-25
2500K | TTCL-D120-U-25-W
2500K |
| TTCL-D120-U-27
2700K | TTCL-D120-U-27-W
2700K |
| TTCL-D120-U-30
3000K | TTCL-D120-U-30-W
3000K |
| TTCL-D120-U-35
3500K | TTCL-D120-U-35-W
3500K |
| TTCL-D120-U-40
4000K | TTCL-D120-U-40-W
4000K |

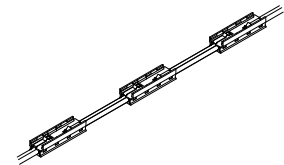

- | | |
|--|--|
| **REPLACEMENT STRAND
BLACK | **REPLACEMENT STRAND
*WHITE |
| TTCL-01-STRAND
¾" O.C. - (25 foot roll) | TTCL-01-STRAND-W
¾" O.C. - (25 foot roll) |
| TTCL-02-STRAND
1½" O.C. - (35 foot roll) | TTCL-02-STRAND-W
1½" O.C. - (35 foot roll) |

**LED PCB Not Included