

CAT:	FEET:
------	-------

TYPE:	PROJECT:
-------	----------



LED lighting system using window ports to create downward illumination and a continuous edge illumination when viewed from above.

Features

- Low-profile Natural or Black anodized aluminum base designed for 90° step angles.
- Tivotape™ are mounted at 45° in a weatherproof, fire-retardant, polycarbonate light tube suitable for outdoor wet applications.
- Shipped from factory pre-cut and pre-assembled in 3', 3½' and 4' lengths with 4' Lead Wire (specify side).
- Also available pre-assembled in custom lengths up to 12 feet (consult factory).

Mounting

Glue and screw down installation using recommended construction adhesives (See page 2).

Applications

Required for 90° indoor and outdoor non-carpeted applications, including concrete and wood. Weatherproof construction for indoor/outdoor wet applications.

Warranty

- 1 year (Aluminum Extrusion)
- 3 years (LED Lighting)

Technical Information



*Lumens/ft	26.5
*Watts/ft	1.3
*Lumen/watt	20
CRI	>70/TYP72
Kelvin Temp	2700K (+/- 100K), 3000K (+/- 100K), 4000K(+/- 250K), 6200K(+/- 250K), Red, Blue, Amber
Rated Life	50,000 hrs.
Maximum Ordering Length	12'
**Ordering Increment	6"
Operating Voltage	12V DC
Power Supply	Class 2
Dimmable	Yes

* 2700K Sample

**Available in .5/ft. increments up to 12'. Specify when ordering.

Profile Dimensions

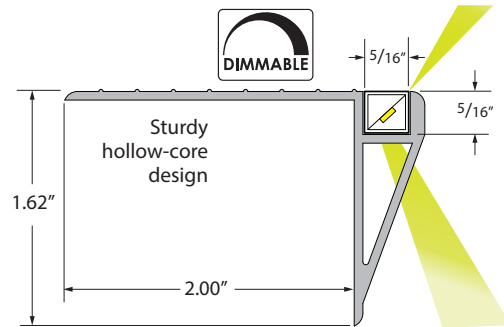

Recommended Power Supplies

ADNM - NON DIMMING

DESCRIPTION	CAT NO	APPLICATION	PRIMARY VOLTAGE	SECONDARY VOLTAGE	MAX LOAD	CIRCUIT BREAKERS	CIRCUIT CAPACITY
ADNM Series Class 2 Transformer	ADNM-60-1-5-12-D	Indoor / Outdoor	100-277V AC 5ø60 HZ	12V DC	60W	1	5A
	ADNM-80-1-5-12-D				60W	1	5A
	ADNM-150-2-5-12-D				2x60W	2	2x5A
	ADNM-240-3-5-12-D				3x60W	3	3x5A
	ADNM-320-4-5-12-D				4x60W	4	4x5A

Recommended Power Supplies

ADNM - 0-10V DIMMING

DESCRIPTION	CAT NO	APPLICATION	PRIMARY VOLTAGE	SECONDARY VOLTAGE	CIRCUIT BREAKERS	MAX LOAD	CIRCUIT CAPACITY
ADNM Series Class 2 Transformer	ADNM-60-1-5-12-DOT	Indoor / Outdoor	100-277V AC 50/60 Hz	12V DC	1	60W	5A
	ADNM-80-1-5-12-DOT				1	60W	5A
	ADNM-150-2-5-12-DOT				2	2x60W	2x5A
	ADNM-240-3-5-12-DOT				3	3x60W	3x5A
	ADNM-320-4-5-12-DOT				4	4x60W	4x5A

ADNM - DMX SINGLE ADDRESS

DESCRIPTION	CAT NO	APPLICATION	PRIMARY VOLTAGE	SECONDARY VOLTAGE	CIRCUIT BREAKERS	MAX LOAD	CIRCUIT CAPACITY
ADNM Series Class 2 Transformer	ADNM-60-1-5-12-DIN	Indoor / Outdoor	100-277V AC 50/60 Hz	12V DC	1	60W	5A
	ADNM-80-1-5-12-DIN				1	60W	5A
	ADNM-150-2-5-12-DIN				2	2x60W	2x5A
	ADNM-240-3-5-12-DIN				3	3x60W	3x5A
	ADNM-320-4-5-12-DIN				4	4x60W	4x5A

ADNM - DMX MULTI ADDRESS

DESCRIPTION	CAT NO	APPLICATION	PRIMARY VOLTAGE	SECONDARY VOLTAGE	CIRCUIT BREAKERS	MAX LOAD	CIRCUIT CAPACITY
ADNM Series Class 2 Transformer	ADNM-150-2-5-12-DIN-2	Indoor / Damp	100-277V AC 50/60 Hz	12V DC	2	2x60W	5A
	ADNM-240-3-5-12-DIN-3				3	3x60W	3x5A

INFINITY - MLV / ELV / 0-10V / PWM / TRIAC

DESCRIPTION	CAT NO	APPLICATION	PRIMARY VOLTAGE	SECONDARY VOLTAGE	CIRCUIT BREAKERS	MAX LOAD	MIN LOAD	CIRCUIT CAPACITY
Infinity Series Class 2 Transformer	INF-J-30-1-2.5-12	Indoor / Outdoor	100 - 277V AC	12VDC	1	30W	3W	2.5A
	INF-J-60-1-5-12				1	60W	6W	5A
	INF-J-180-3-5-12				3	3x60W	3x6W	3x5A
	INF-J-300-5-5-12				5	5x60W	5x6W	5x5A

Recommended Dimmers

DIMMING - 0-10V

DESCRIPTION	CAT NO	APPLICATION	INPUT VOLTAGE	OUTPUT VOLTAGE	MAX LOAD
0-10V Dimmer	DIM-LD-010	Indoor	24V DC	24V DC	30 mA max. output (sink only)

Recommended Dimmers

DIMMING - MLV

DESCRIPTION	CAT NO	APPLICATION	INPUT VOLTAGE	OUTPUT VOLTAGE	MAX LOAD
MLV Dimmer	N-600	Indoor	120V AC	120V AC	450W
	N-1000				800W
	N-1500				1200W
	D-600				450W
	M-600				450W
	M-1000				800W

DIMMING - ELV

DESCRIPTION	CAT NO	APPLICATION	INPUT VOLTAGE	OUTPUT VOLTAGE	MAX LOAD
ELV Dimmer	ME-600	Indoor	120V AC	120V AC	450W
	DE-300				300W

DIMMING - DMX

DESCRIPTION	CAT NO	APPLICATION	INPUT VOLTAGE	OUTPUT PROTOCOL	MAX UNIVERSE
DMX Controller	TVOQ-1-WH	Indoor	5V DC	DMX 512	1
	TVOQ-2-BK		6V DC		
	TVOQ-2-WH				
	TVOQ-10-BK-7		6-7V DC		2
	TVOQ-10-WH-7				



Touchscreen

TVOQ-1-WH
WH (White only)

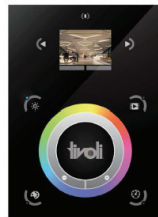

Touchscreen

TVOQ-10-XX-7
XX = BK (Black), WH (White)

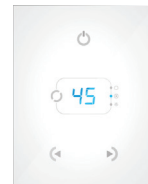

Touchscreen

TVOQ-2-XX
XX = BK (Black), WH (White)

Ordering Information

PRODUCT CODE	LED COLOR	LED SPACING	POWER FEED	FINISH	*LENGTH
PBS		C			
PBS = Premium Bare Step	27 = 2700K 30 = 3000K 40 = 4000K 62 = 6200K AM = Amber RD = Red BL = Blue	C = Continuous	L = Left R = Right B = Both	BK = Black Anodized NA = Natural Aluminum	3.0 = 3' 3.5 = 3.5' 4.0 = 4'

*Bare Step is manufactured to specified lengths to within 1/8" Available in .5/ft. increments up to 12' (consult factory)

Mounting Accessories

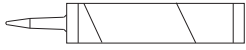

EXTRUSION ADHESIVE
ADH-MB-75AM-10
 Extrusion adhesive, 10.1 oz tubes, sold individually, 30 per case.
ADH-MB-75AM-29
 Extrusion adhesive, 29 oz tubes, sold individually, 12 per case.

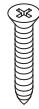

TM-3/16
 Concrete Screw 3/16" x 1 3/4"



RONDB-5/32
 Concrete Drill Bit 5/32"

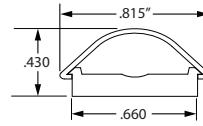

BS-CC-8
 Wall wireway, 8" Black Base & Conduit Cover

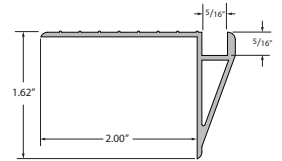

REPLACEMENT ALUMINUM BASE*
PBS-AL-BSE-NA (Natural Aluminum)
PBS-AL-BSE-BK (Black)
 Replacement Premium Bare Step base

*Due to custom cut windows, exact step length is required at the time of ordering with desired existing on center spacing.

Replacement Parts

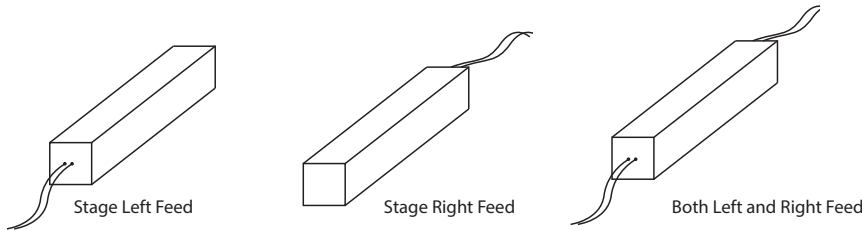

REPLACEMENT STRAND (2700°K)
PBS-LF-27-3.0
 3' Clear Tube, Left Hand Feed
PBS-LF-27-3.5
 3 1/2' Clear Tube, Left Hand Feed
PBS-LF-27-4.0
 4' Clear Tube, Left Hand Feed
PBS-RF-27-3.0
 3' Clear Tube, Right Hand Feed
PBS-RF-27-3.5
 3 1/2' Clear Tube, Right Hand Feed
PBS-RF-27-4.0
 4' Clear Tube, Right Hand Feed
PBS-BF-27-3.0
 3' Clear Tube, Both End Feed
PBS-BF-27-3.5
 3 1/2' Clear Tube, Both End Feed
PBS-BF-27-4.0
 4' Clear Tube, Both End Feed

REPLACEMENT STRAND (3000°K)
PBS-LF-30-3.0
 3' Clear Tube, Left Hand Feed
PBS-LF-30-3.5
 3 1/2' Clear Tube, Left Hand Feed
PBS-LF-30-4.0
 4' Clear Tube, Left Hand Feed
PBS-RF-30-3.0
 3' Clear Tube, Right Hand Feed
PBS-RF-30-3.5
 3 1/2' Clear Tube, Right Hand Feed
PBS-RF-30-4.0
 4' Clear Tube, Right Hand Feed
PBS-BF-30-3.0
 3' Clear Tube, Both End Feed
PBS-BF-30-3.5
 3 1/2' Clear Tube, Both End Feed
PBS-BF-30-4.0
 4' Clear Tube, Both End Feed

REPLACEMENT STRAND (4000°K)
PBS-LF-40-3.0
 3' Clear Tube, Left Hand Feed
PBS-LF-40-3.5
 3 1/2' Clear Tube, Left Hand Feed
PBS-LF-40-4.0
 4' Clear Tube, Left Hand Feed
PBS-RF-40-3.0
 3' Clear Tube, Right Hand Feed
PBS-RF-40-3.5
 3 1/2' Clear Tube, Right Hand Feed
PBS-RF-40-4.0
 4' Clear Tube, Right Hand Feed
PBS-BF-40-3.0
 3' Clear Tube, Both End Feed
PBS-BF-40-3.5
 3 1/2' Clear Tube, Both End Feed
PBS-BF-40-4.0
 4' Clear Tube, Both End Feed

REPLACEMENT STRAND (6200°K)
PBS-LF-62-3.0
 3' Clear Tube, Left Hand Feed
PBS-LF-62-3.5
 3 1/2' Clear Tube, Left Hand Feed
PBS-LF-62-4.0
 4' Clear Tube, Left Hand Feed
PBS-RF-62-3.0
 3' Clear Tube, Right Hand Feed
PBS-RF-62-3.5
 3 1/2' Clear Tube, Right Hand Feed
PBS-RF-62-4.0
 4' Clear Tube, Right Hand Feed
PBS-BF-62-3.0
 3' Clear Tube, Both End Feed
PBS-BF-62-3.5
 3 1/2' Clear Tube, Both End Feed
PBS-BF-62-4.0
 4' Clear Tube, Both End Feed

REPLACEMENT STRAND (AMBER)
PBS-LF-AM-3.0
 3' Clear Tube, Left Hand Feed
PBS-LF-AM-3.5
 3 1/2' Clear Tube, Left Hand Feed
PBS-LF-AM-4.0
 4' Clear Tube, Left Hand Feed
PBS-RF-AM-3.0
 3' Clear Tube, Right Hand Feed
PBS-RF-AM-3.5
 3 1/2' Clear Tube, Right Hand Feed
PBS-RF-AM-4.0
 4' Clear Tube, Right Hand Feed
PBS-BF-AM-3.0
 3' Clear Tube, Both End Feed
PBS-BF-AM-3.5
 3 1/2' Clear Tube, Both End Feed
PBS-BF-AM-4.0
 4' Clear Tube, Both End Feed

REPLACEMENT STRAND (RED)
PBS-LF-RD-3.0
 3' Clear Tube, Left Hand Feed
PBS-LF-RD-3.5
 3 1/2' Clear Tube, Left Hand Feed
PBS-LF-RD-4.0
 4' Clear Tube, Left Hand Feed
PBS-RF-RD-3.0
 3' Clear Tube, Right Hand Feed
PBS-RF-RD-3.5
 3 1/2' Clear Tube, Right Hand Feed
PBS-RF-RD-4.0
 4' Clear Tube, Right Hand Feed
PBS-BF-RD-3.0
 3' Clear Tube, Both End Feed
PBS-BF-RD-3.5
 3 1/2' Clear Tube, Both End Feed
PBS-BF-RD-4.0
 4' Clear Tube, Both End Feed

REPLACEMENT STRAND (BLUE)
PBS-LF-BL-3.0
 3' Clear Tube, Left Hand Feed
PBS-LF-BL-3.5
 3 1/2' Clear Tube, Left Hand Feed
PBS-LF-BL-4.0
 4' Clear Tube, Left Hand Feed
PBS-RF-BL-3.0
 3' Clear Tube, Right Hand Feed
PBS-RF-BL-3.5
 3 1/2' Clear Tube, Right Hand Feed
PBS-RF-BL-4.0
 4' Clear Tube, Right Hand Feed
PBS-BF-BL-3.0
 3' Clear Tube, Both End Feed
PBS-BF-BL-3.5
 3 1/2' Clear Tube, Both End Feed
PBS-BF-BL-4.0
 4' Clear Tube, Both End Feed